



Since 1990 up today UNION company is the market leader in the production of doors and furniture.

UNION always strive for excellence, concentrating its efforts on finding new ideas, implementing European quality standards, enlarging the product range and introducing the latest trends in architecture and interior design.

Being an expert in interior doors and partitions development, in 2020 UNION launched to the market a new comprehensive approach to interior design.

The concept of "Doors and furniture in the same style" was developed by Italian architects on request and in collaboration with UNION. This solution makes easier implementation the ideas of architects working out an interior and guarantees the stylistic unity of all elements in the design project.

\ Modern doors

FILO-60	14
UNIFLEX-3D	26
LAGO-60	30
SLIM	36
TONDA	40
PIVOT	42
UNIX	43

\ Traditional doors

TREND-60	44
ALDA-60	46
LEVEL-60	47
CORDA-60	48
GRAND-60	49
PRIMA-60	50
STELLA	51

\ Sliding doors and partitions

SLIDER	52
MAGIC	53
STRATUS	54
TRANSFORMER	68
WALLSTREET	69

\ Wall panels

COVER	70
-------	----

\ Metal entrance doors

DELTApro	75
----------	----

\ Walk-in closets and storage systems

ALTO	76
FORMINA	80

\ Shelving and bookcases

FORTE	82
-------	----

\ Dining and coffee tables

MILAN	86
LOTUS	88
MOON	89

\ Modular sofas

PORTOFINO	90
-----------	----

\ Skirting boards

UNION CONTRACT	94
----------------	----

\ Fittings and accessories

	96
--	----

\ Materials and finishes

	98
--	----

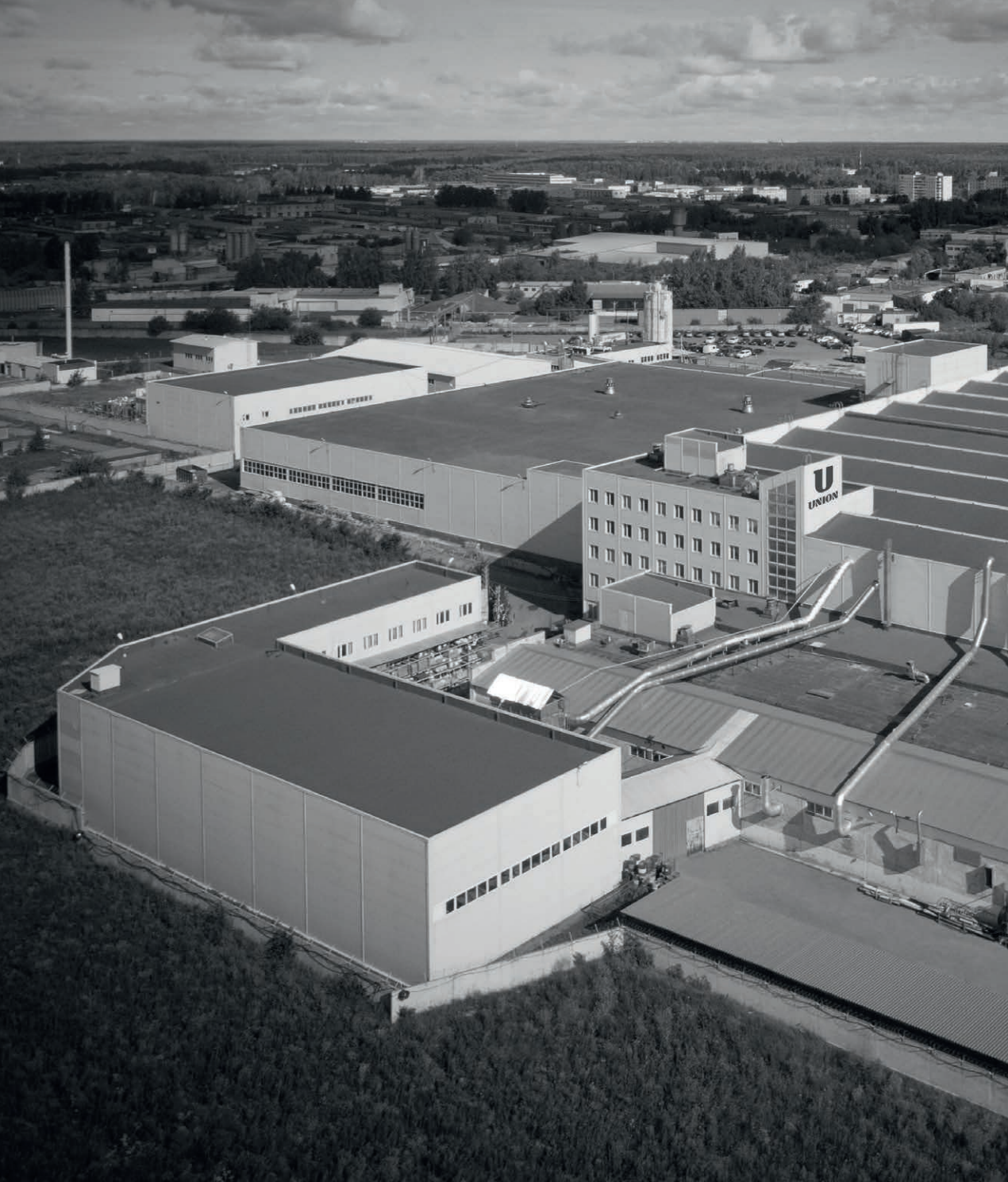

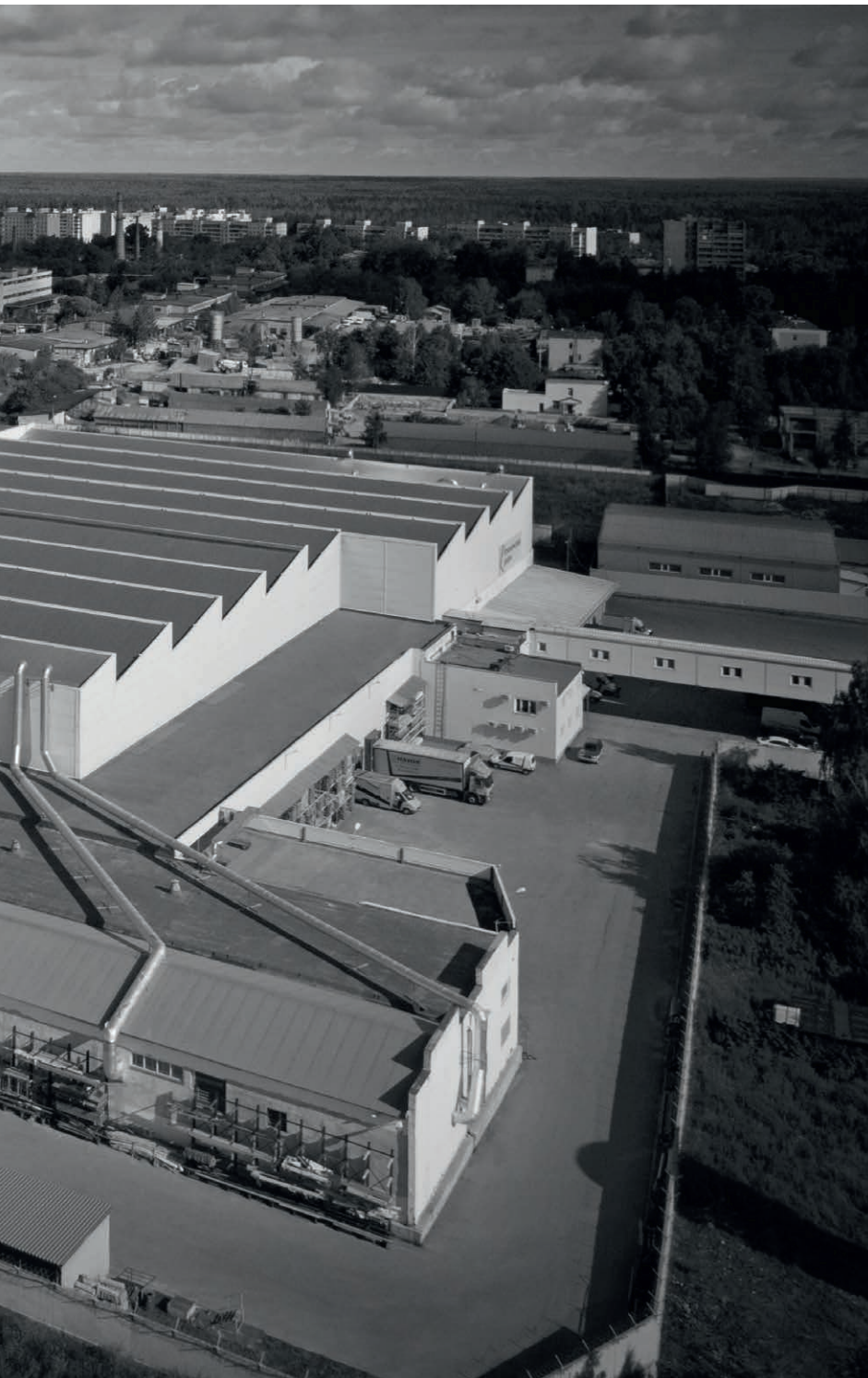

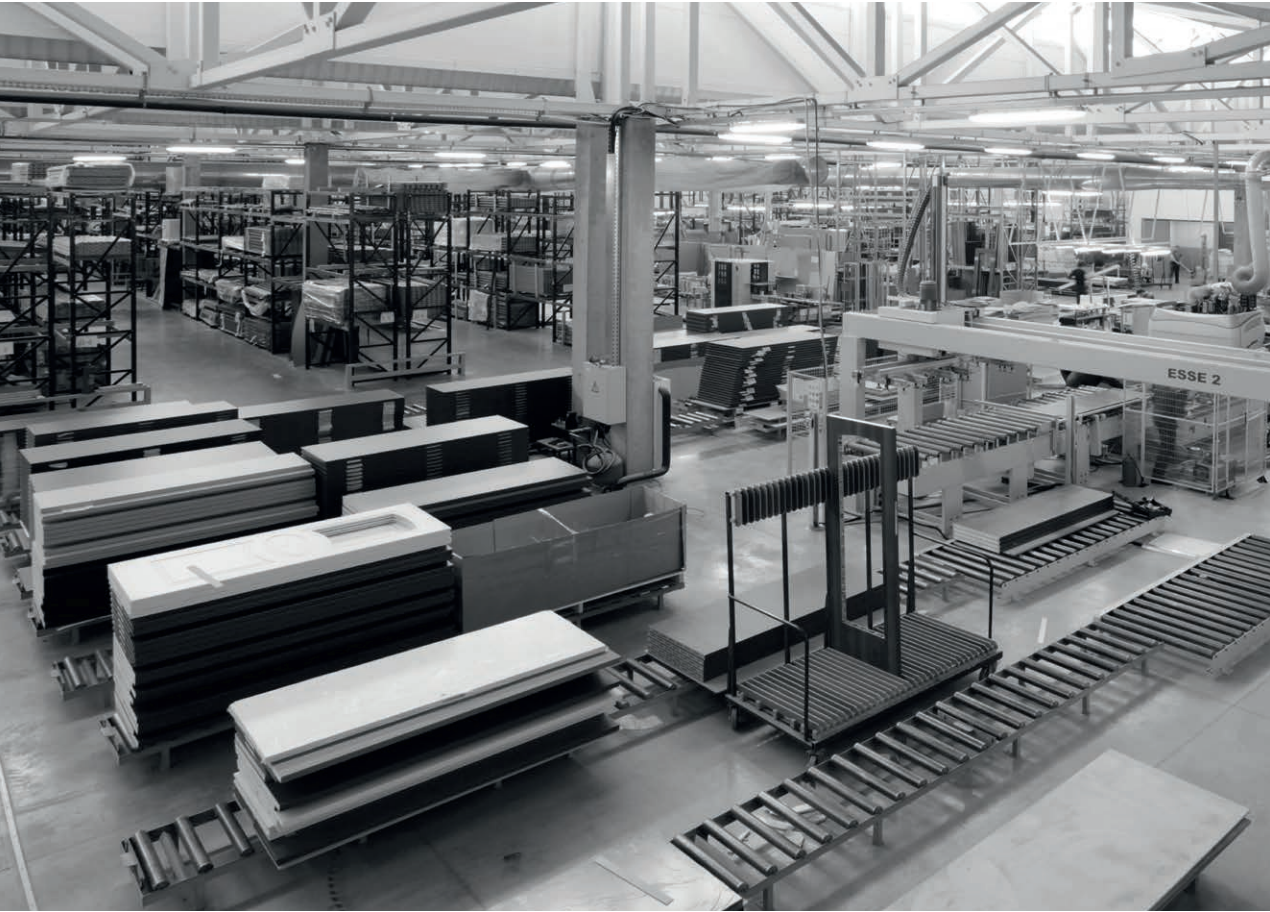

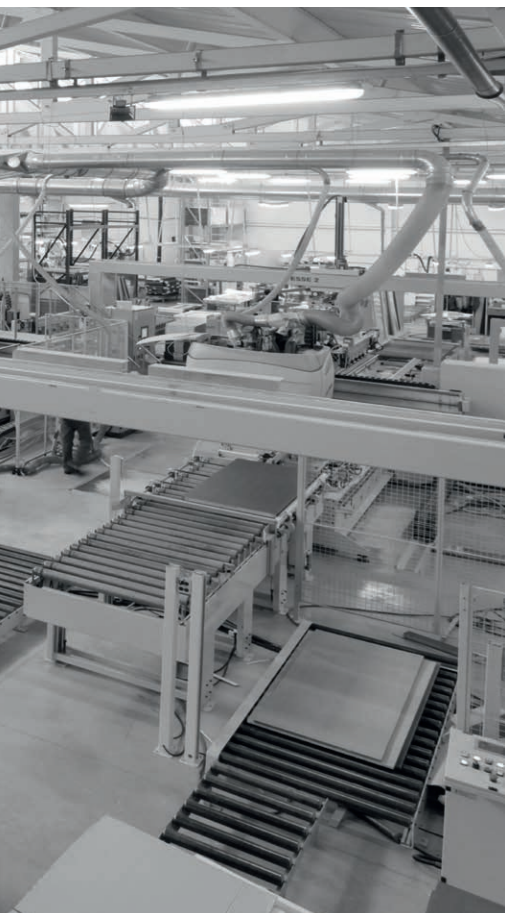

UNION company production was established according to the project of Italian architects based on the latest achievements of the Italian furniture industry. Our advanced production complex operates on more than 40,000 sqm and equipped with modern Italian and German hardware matching fulfillment of any complexity orders in the required volume. Majoring the implementation of complex interior solutions, the UNION company has reached the highest level of the development, thanks to the knowledge of the Italian door and furniture manufacturing traditions, the involve of European experience, technologies and equipment, as well as understanding the customers needs and constant improvement of products and services.

SIZE MATTERS

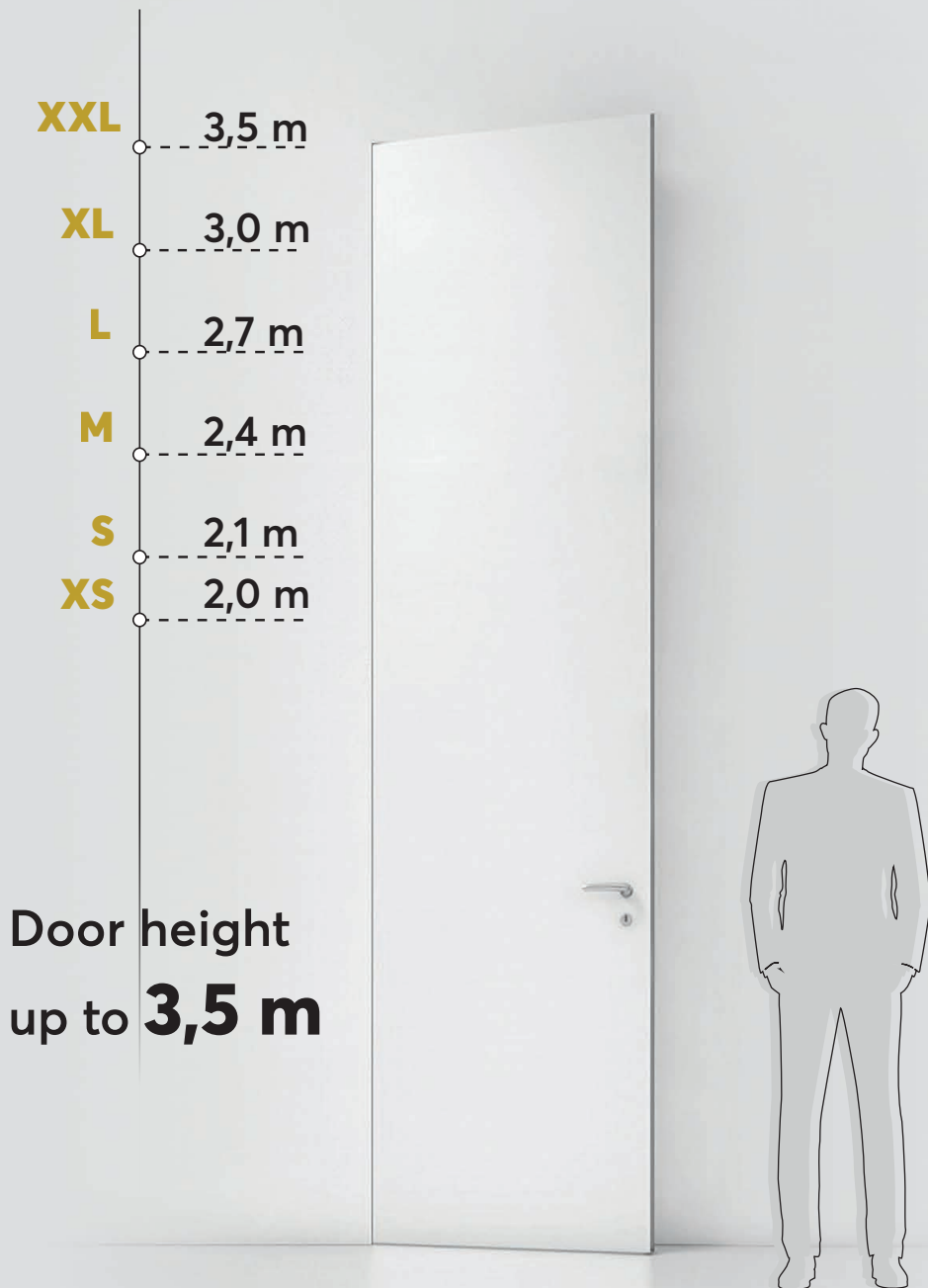

Thickness of UNION door up to **60 mm**

It's **50%** thicker
than an standard door

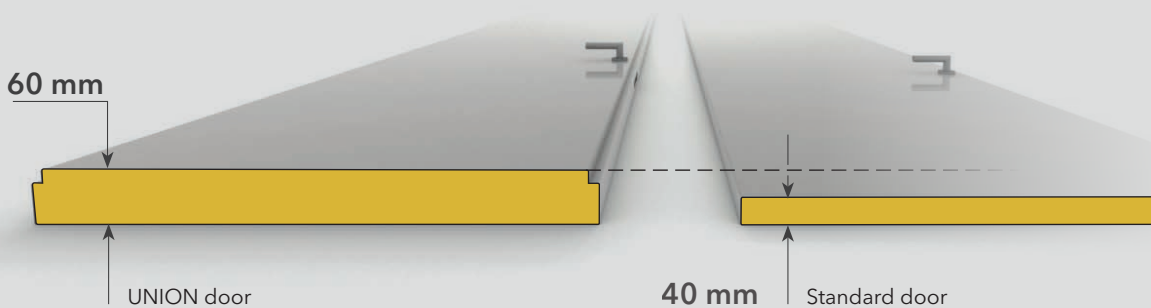

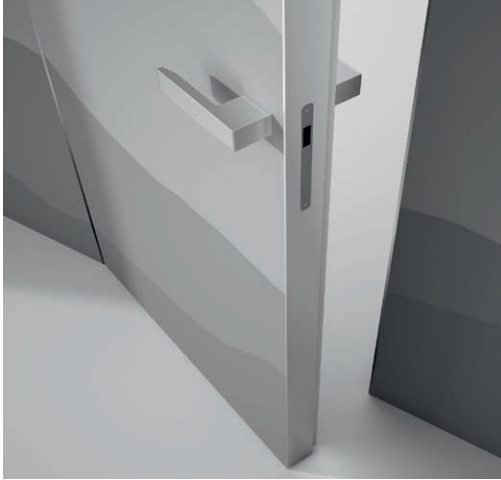

02

Important advantage - door leaf thickness

As a rule, the door leaf thickness of other manufacturers does not exceed 40 mm. The leaf thickness of UNION doors is 60 mm. Such doors have better sound insulation and durability. Besides all, they look prestigious and give the solidity to the interior.

04

Height up to 3.5 meters

Modern trend, relevant for interiors made in different design. They lift up the ceilings, visually enlarge the room space. Reinforced frame and door leaf structure provides the strength and stability during a long-term operation.



01

Always in stock. Invisible doors ready to for painting

Always in stock, ready for quick shipment, unique FILO-60, Fondo doors with 60mm thickness in standard sizes 60/70/80 x 200/210/240 cm.

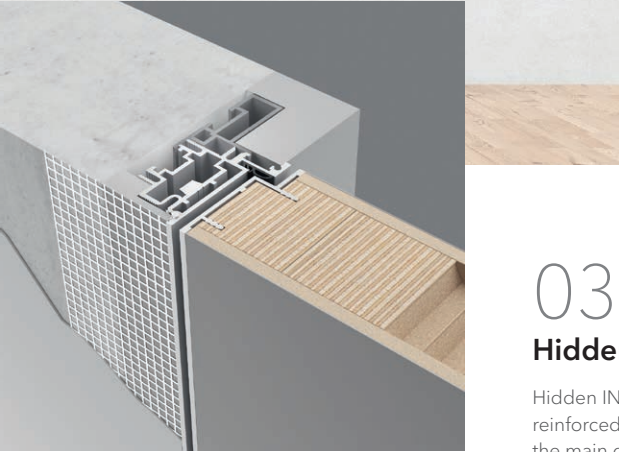

03

Hidden frame with false frame

Hidden INVISIBLE frame is totally made from aluminum and it is reinforced by false frame - the additional secondary profile. That's the main difference between the constructions of UNION hidden frames from any standard hidden frames in a market. The rigid reliable construction is designed for long and intensive operation, including for heavy doors. Initially the frame is anodized in silver aluminum, but it can be also painted in a wall color or in any color according to the factory catalogue.

05

Complanarity

NVISIBLE hidden frame is integrated in a wall and creates one plane at "pull opening" and "push opening" door. Moreover, it's convenient to add the wall panels from different materials (from wood to glass) to this frame. In any case the complanarity has place - the solidity of surface with wall without protuberances.





06

Wall thickness

There are thin walls made from special materials in construction of some buildings. INVISIBLE frame is ideal for wall mounting from 6 cm thickness. The frame is installed in a thin wall without using a false frame and fixed via frame profile.

07

Delivery of the assembled frame

The INVISIBLE hidden frame can be delivered fully assembled. It means that the frame is assembled with fixed mounting bars ready to be installed in the doorway. The installers can only set it vertically and fix it to the slopes opening. Thus the installation becomes faster and easier.



08

Aesthetic mounting

The INVISIBLE frame design allows you to create a joint with the tiles, the porcelain tiles or other materials directly tightly, without additional transitional elements and visible gaps. Such a technical solution is specifically provided for doors on hidden frame of both internal and external opening.



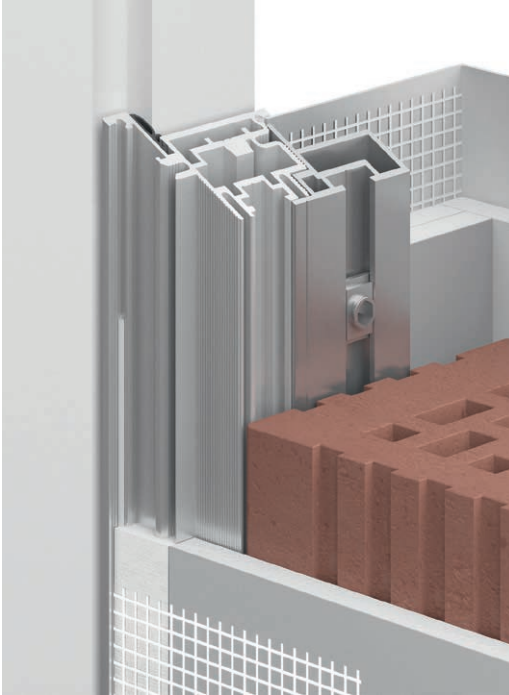

09

Support

There are longitudinal grooves in the profile of the false frame. The tool carriages are installed in these grooves. It is a special fixing device that allows adjusting quickly the frame position by level and then fastening securely the whole construction. It accelerates and simplifies the installation process. Minimum 4 tool carriages are installed in each vertical wall stand of INVISIBLE frame (there are always two of them).

10

Suitable for standard doorways

According to international standards, the door's width 60, 70, 80 and 90 cm are standard. As a rule, many builders prepare the doorways exactly in accordance with those standards. UNION hidden frame doors are designed the way that their geometric dimensions fit into standard doorways that significantly reduce their cost.

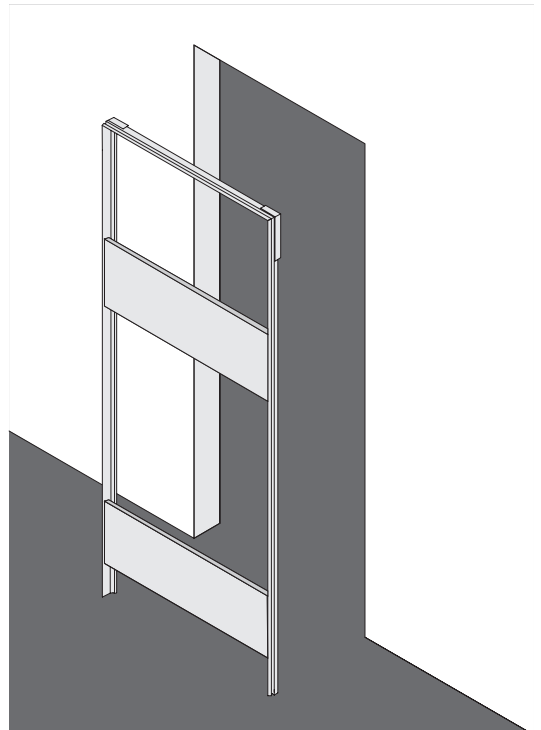



11

Humidity resistance

Aluminum INVISIBLE frame makes a door humidity resistant, in contrast to the doors on wood or MDF frame. UNION doors are not exposed to humidity during the wet cleaning or at the wet floor. They can be used in high humidity rooms without fear of wet support structure - the frame.

12

Fabricability

INVISIBLE hidden frame are supplied with a special supporting net along the whole aluminum frame perimeter. This is the important detail when a wall is plastered close to the frame and then painted. The net simplifies the plastering process and excludes the cracks of the wall surface.

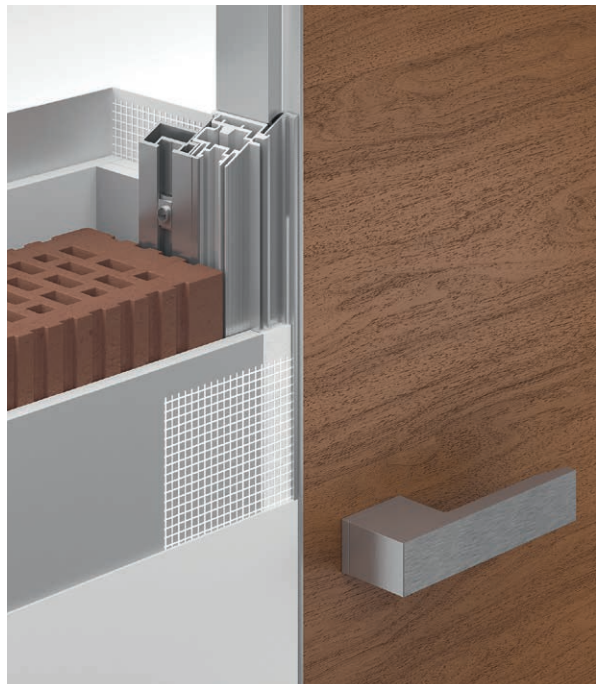



13

Solidity of finishing

There is a very interesting and trendy option in UNION - the possibility of factory polymer painting in the same color of all metal elements of the door structures. The solidity of finishing of aluminum tip edge, frame and handles create a unique aesthetic integrity and laconism.

14

Rabbeted door

UNION produces the unique 60 mm doors with so-called rabetted ledge. Sometimes we use the terms "doors with groove" or "framed-and-ledged doors" instead of "rabbeted doors". Thanks to the ledge, the door leaf connects better to the frame that increases the sound and heat insulations. Due to the ledge the door becomes flush at different door handing - "pull opening" and "push opening". The ledge also prevents the light penetration in another room.



15

Aluminum - Low footprint

Aluminum is a natural, eco-friendly and safe material that is not exposed to the environment. Such materials as wooden board, MDF have a number of fundamental defects - they trigger and swell on wetting. There are the doors with PVC elements in a market. This material is very harmful for humans.



FILO-60

INVISIBLE DOORS



Hidden door in classical interior



INVISIBLE frame



INVISIBLE Inverso frame

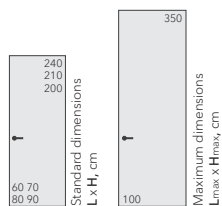

LACCATO MATT
Matt enamels
(L00 Fondo)



LACCATO GLOSS
Gloss enamels



HPL
Composite
material



VENEER NATURAL
Natural wood
veneer



ALUMINIUM
Anodised and
polymer coatings



FILO-60, Piatto, L00 Fondo / INVISIBLE

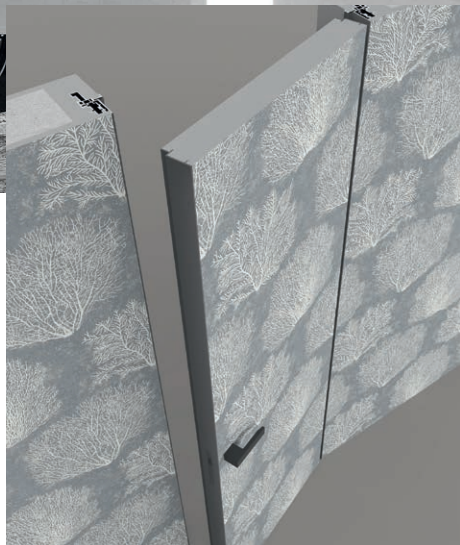

Wallpapering the door and the wall together

FILO-60

MATTE AND GLOSSY ENAMELS



FILO-60, Piatto, L10 Nero / INVISIBLE

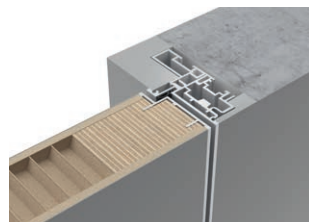

INVISIBLE frame



PLANAR frame

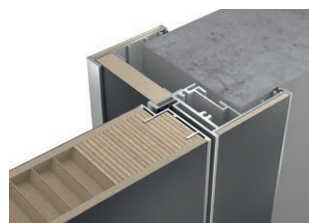

PLANAR frame with insert



UNIDOOR frame

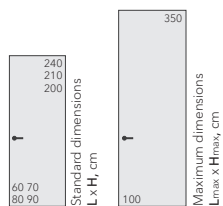

LACCATO MATT
Matt enamels



LACCATO GLOSS
Gloss enamels



HPL
Composite material



VENEER NATURAL
Natural wood veneer



ALUMINIUM
Anodised and polymer coatings



FILO-60, Piatto, LG11 Tortora Gloss / INVISIBLE

FILO-60

COMPOSITE DECORATIVE MATERIAL

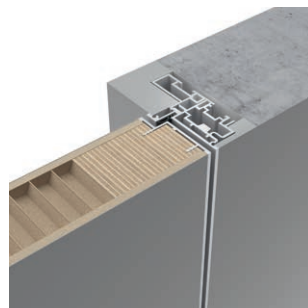

INVISIBLE frame



PLANAR frame

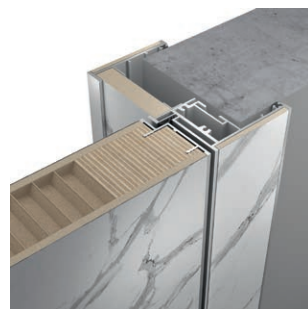

PLANAR frame with insert

FILO-60, Piatto, L10 Nero / INVISIBLE

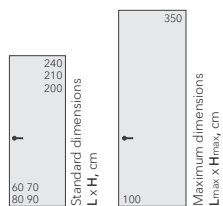

LACCATO MATT
Matt enamels



LACCATO GLOSS
Gloss enamels



HPL
Composite material



VENEER NATURAL
Natural wood veneer



ALUMINIUM
Anodised and polymer coatings



FILO-60, Piatto, HP04 Marmo Bianco / INVISIBLE

FILO-60

NATURAL WOOD VENEER

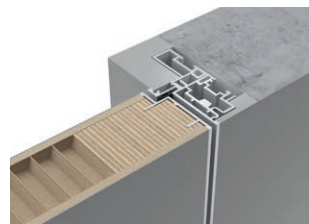

INVISIBLE frame

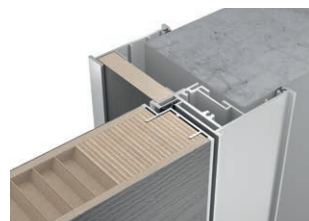

PLANAR frame

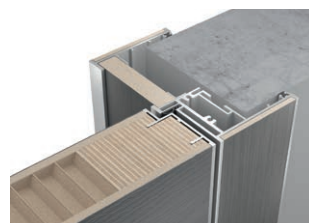

PLANAR frame with insert



UNIDOOR frame

FILO-60, Vento, V10 Rovere Antico / INVISIBLE

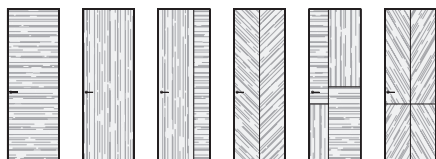

Vento Velino Vetta Valetti Vezana Vox

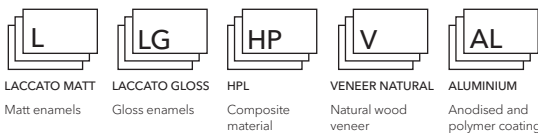
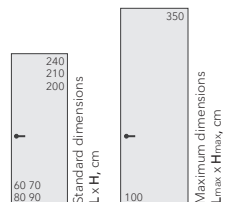



FILO-60

NATURAL WOOD VENEER

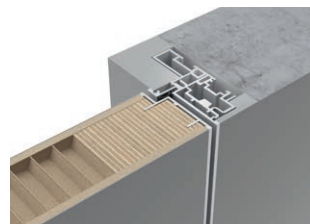

INVISIBLE frame

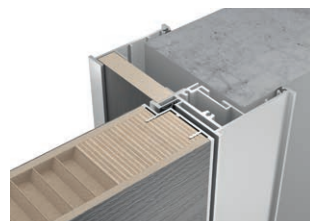

PLANAR frame

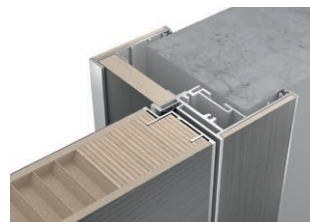

PLANAR frame with insert

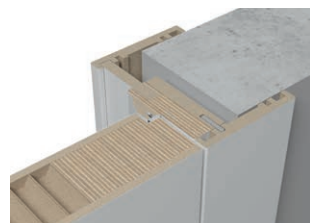

UNIDOOR frame

FILO-60, Vetta, V11 Rovere Tetro / INVISIBLE

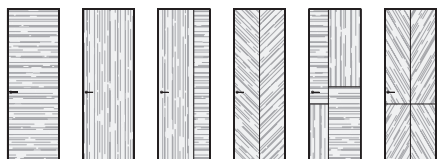

Vento

Velino

Vetta

Valetti

Vezana

Vox

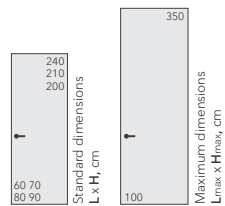

LACCATO MATT
Matt enamels



LACCATO GLOSS
Gloss enamels



HPL
Composite material



VENEER NATURAL
Natural wood veneer



ALUMINIUM
Anodised and polymer coatings



FILO-60, Alu, Valetti, V03 Ebano / INVISIBLE

FILO-60

НАТУРАЛЬНЫЙ ШПОН

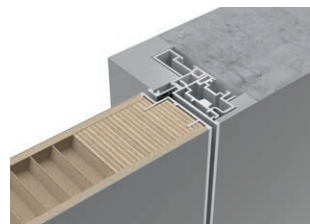

INVISIBLE frame

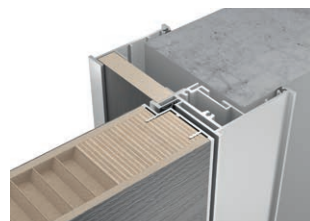

PLANAR frame

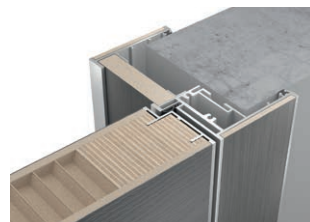

PLANAR frame with insert

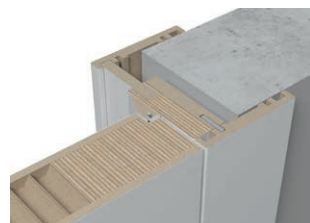

UNIDOOR frame

FILO-60, Vento, V16 Noce Canaletto / PLANAR

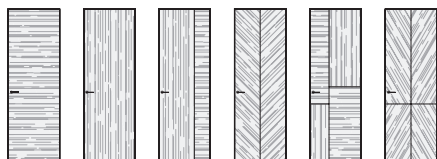

Vento

Velino

Vetta

Valetti

Vezana

Vox

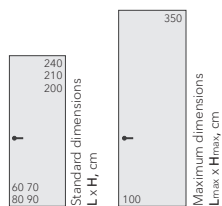

LACCATO MATT
Matt enamels



LACCATO GLOSS
Gloss enamels



HPL
Composite material



VENEER NATURAL
Natural wood veneer



ALUMINIUM
Anodised and polymer coatings



UNIFLEX-3D

3D MILLING AND RELIEF PATTERN (SOLID, VENEER)

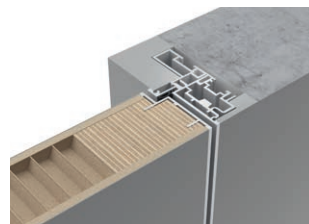

INVISIBLE frame

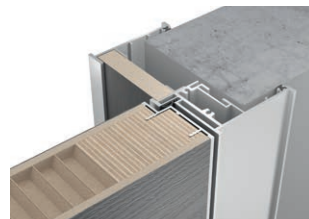

PLANAR frame

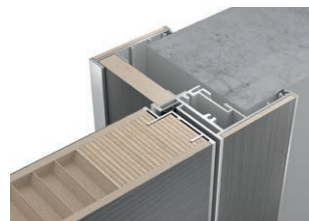

PLANAR frame with insert

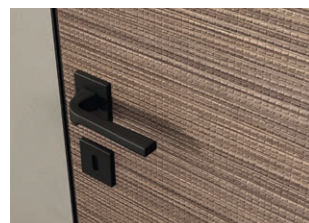

UNIFLEX-3D, Alu, Bolla, UB16 Noce Canaletto / INVISIBLE

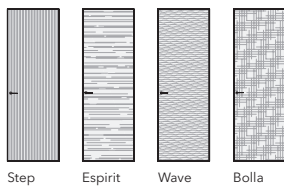

Step Espirit Wave Bolla

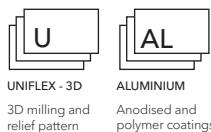
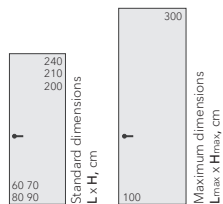

UNIFLEX - 3D
3D milling and relief pattern

ALUMINIUM
Anodised and polymer coatings



UNIFLEX-3D, Alu, Step, US16 Noce Canaletto / PLANAR

UNIFLEX-3D

3D MILLING AND RELIEF PATTERN (SOLID, VENEER)

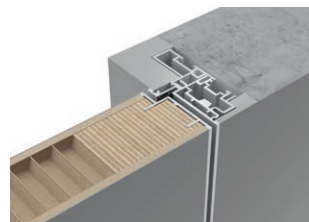

INVISIBLE frame

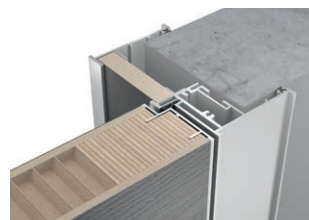

PLANAR frame

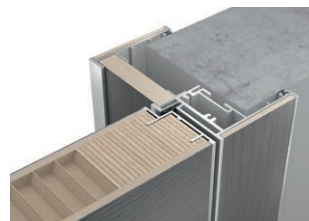

PLANAR frame with insert



UNIFLEX-3D, Alu, Wave, UW16 Noce Canaletto / INVISIBLE

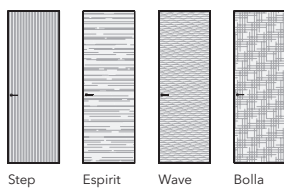

Step Espirit Wave Bolla

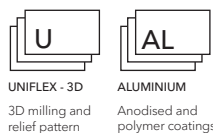
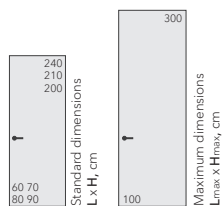

UNIFLEX - 3D
3D milling and relief pattern

ALUMINIUM
Anodised and polymer coatings



UNIFLEX-3D, Alu, Espirit, US16 Noce Canaletto / INVISIBLE

LAGO-60

DOUBLE GLASS IN AN REFINED FRAME

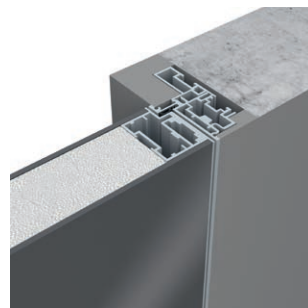

INVISIBLE frame

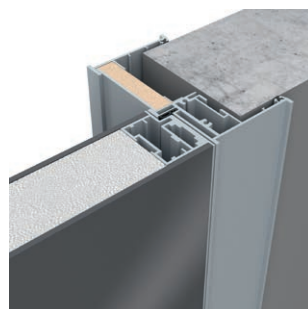

PLANAR frame

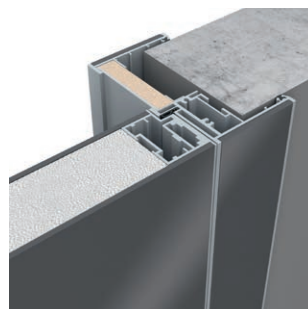

PLANAR frame with insert

LAGO-60, Piatto, G01 Bianco / INVISIBLE

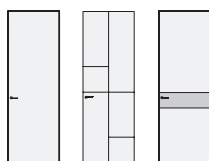

Piatto Modelica Plain

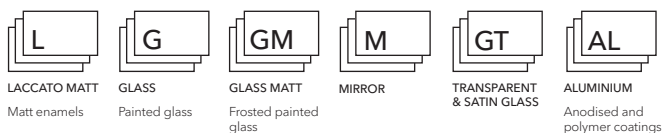
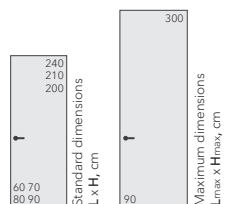



LAGO-60, Piatto, G10 Nero / INVISIBLE

LAGO-60

DOUBLE GLASS IN AN REFINED FRAME

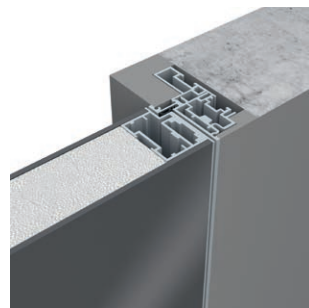

INVISIBLE frame

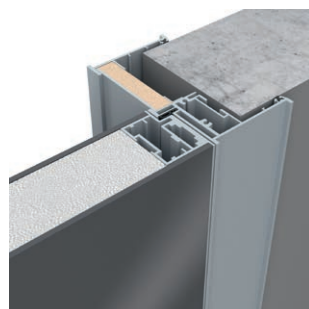

PLANAR frame

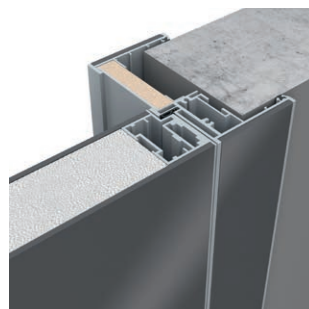

PLANAR frame with insert

LAGO-60, Plain, G10 Nero, вставка LM11 Fokos Piombo / INVISIBLE

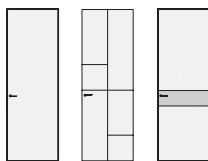

Piatto Modelica Plain

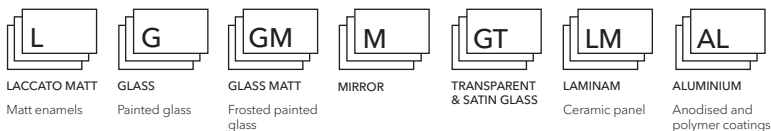
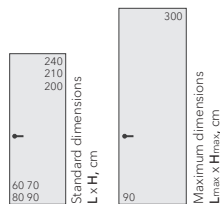



LAGO-60, Modelica, G06 Grigio Seta / INVISIBLE

LAGO-60

DOUBLE GLASS IN AN REFINED FRAME

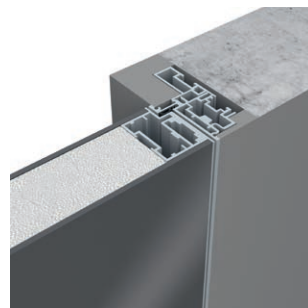

INVISIBLE frame

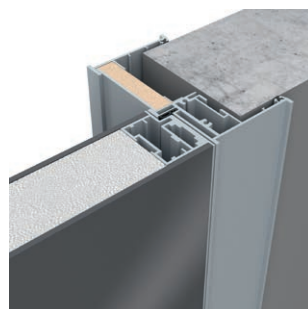

PLANAR frame

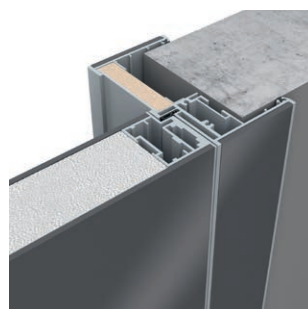

PLANAR frame with insert

LAGO-60, Piatto, G13 Rocca / PLANAR

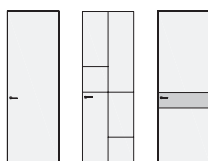

Piatto Modelica Plain

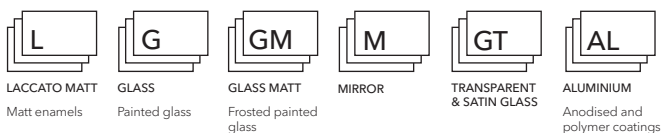
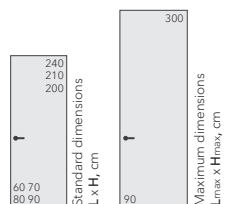



SLIM

DECORATIVE GLASS IN ALUMINIUM STRUCTURES

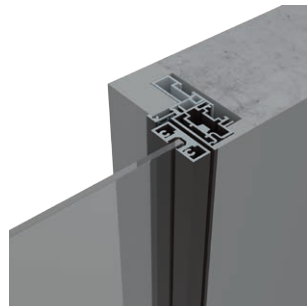

INVISIBLE frame

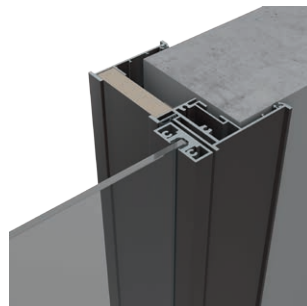

PLANAR frame

SLIM, Piatto, GT05 Trasparente Sole / INVISIBLE

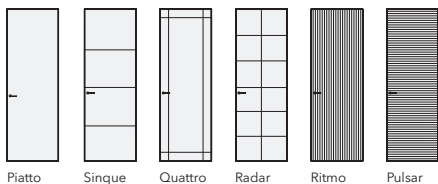

Piatto

Sinque

Quattro

Radar

Ritmo

Pulsar

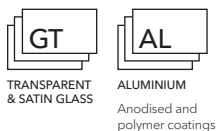
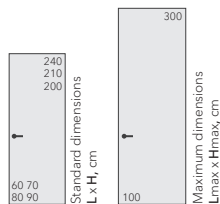

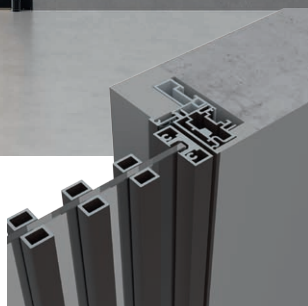
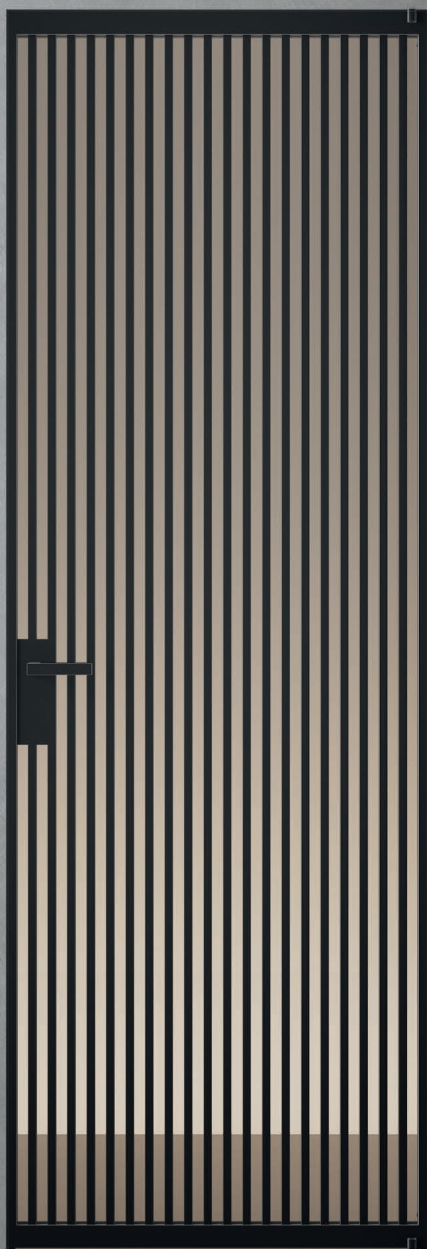

SLIM, Ritmo, GT03 Trasparente Bronze / INVISIBLE

SLIM

DECORATIVE GLASS IN ALUMINIUM STRUCTURES

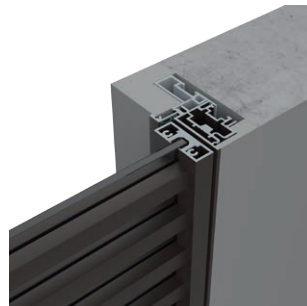
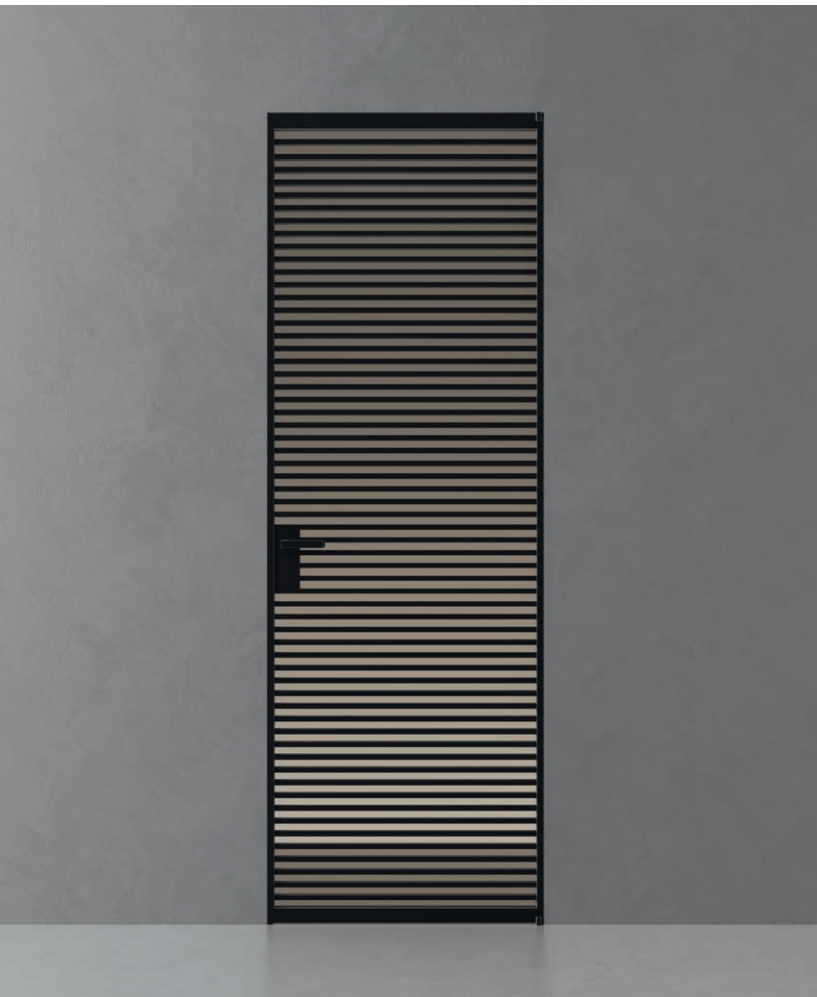

INVISIBLE frame

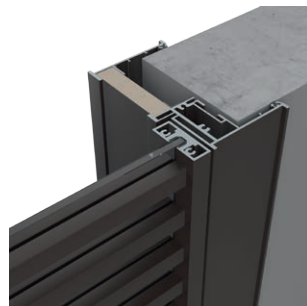

PLANAR frame

SLIM, Pulsar, GT03 Trasparente Bronze / INVISIBLE

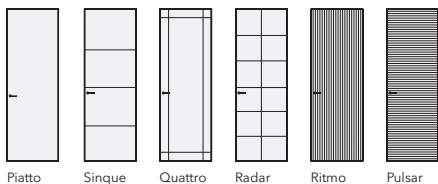

Piatto Sinque Quattro Radar Ritmo Pulsar

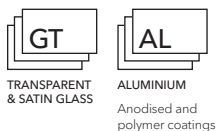
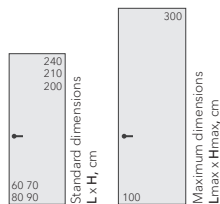

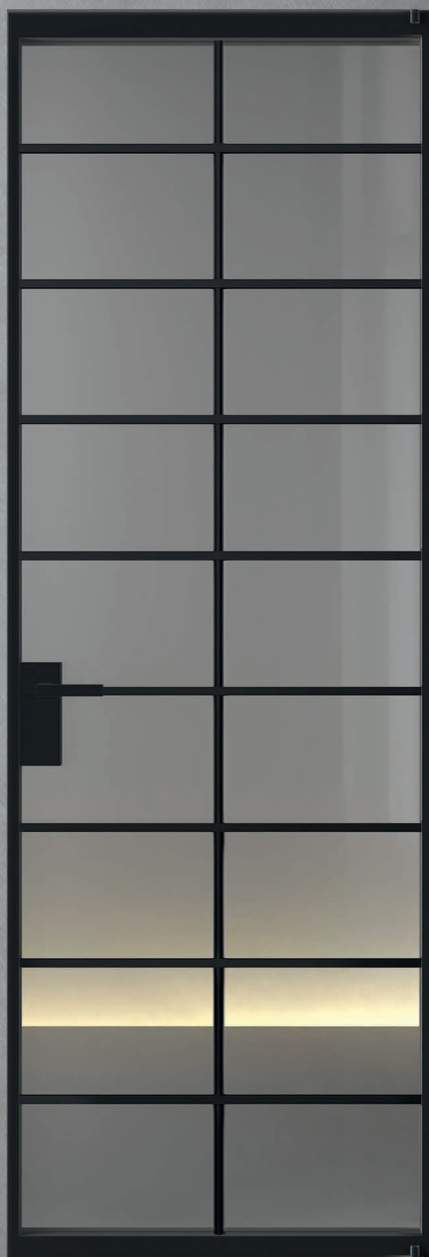

SLIM, Radar, GT02 Trasparente Grafite / INVISIBLE

TONDA

PREMIUM DOORS WITH ROUNDED EDGES



TONDA, Ego, LG01 Bianco Gloss



TONDA frame without adjustment





TONDA frame with adjustment



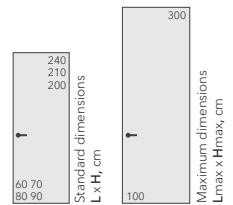

Piatto Ego



- 

L
LACCATO MATT
Matt enamels
- 

LG
LACCATO GLOSS
Gloss enamels
- 

V
VENEER NATURAL
Natural wood veneer
- 

AL
ALUMINIUM
Anodised and polymer coatings



PIVOT

PIVOTING DOORS



PIVOT-60, L00 Fondo / INVISIBLE



PIVOT-45, without frame



PIVOT-60, INVISIBLE frame

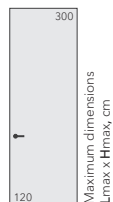

LACCATO MATT
Matt enamels



HPL
Composite material



VENEER NATURAL
Natural wood veneer



LACCATO GLOSS
Gloss enamels



UNIFLEX - 3D
3D milling and relief pattern



ALUMINIUM
Anodised and polymer coatings

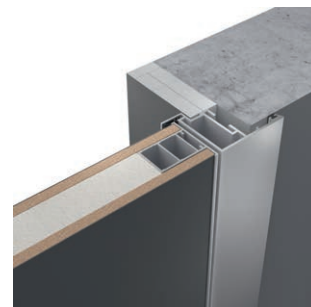

U-SYSTEM frame without adjustment panel

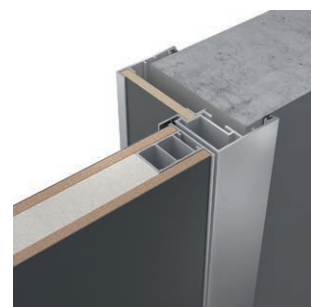

U-SYSTEM frame with adjustment panel

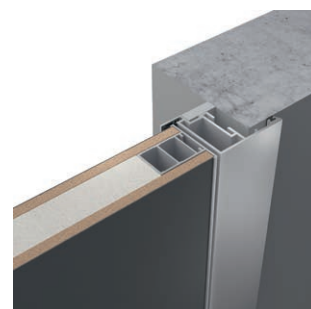

U-SYSTEM frame
Installation in an finished opening

UNIX, Piatto, DC01 Neve / U-SYSTEM

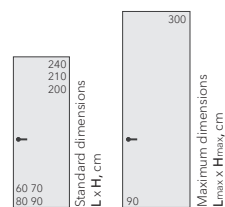

DC
DECORIT
Decorative
material



AL
ALUMINIUM
Anodised and polymer
coatings

TREND-60

TRADITIONAL DOORS



TREND-60, TR15, L13 Rocca / UNIDOOR



UNIDOOR frame

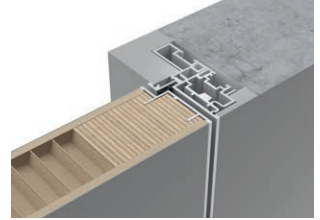

INVISIBLE frame



PLANAR frame

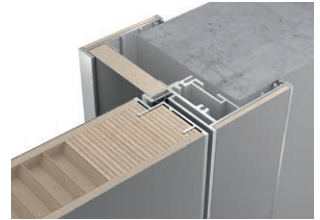

PLANAR frame with insert

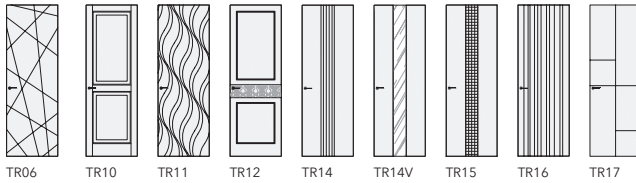

TR06 TR10 TR11 TR12 TR14 TR14V TR15 TR16 TR17

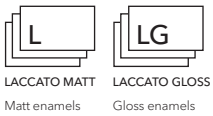
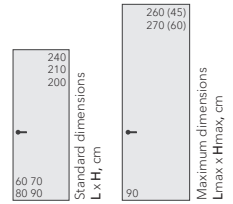



TREND-60, TR16, L01 Bianco / INVISIBLE

ALDA-60

NEOCLASSICAL STYLE DOORS



ALDA-60, 101, L01 Bianco / UNIDOOR



UNIDOOR frame

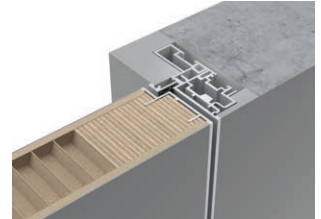

INVISIBLE frame



PLANAR frame



PLANAR frame with insert

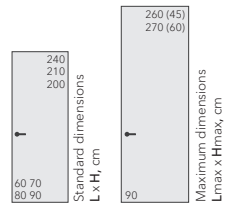
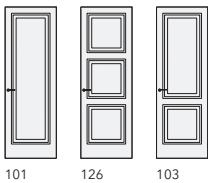

LEVEL-60

TRADITIONAL DOORS



LEVEL-60, 101, L01 Bianco / UNIDOOR



UNIDOOR frame

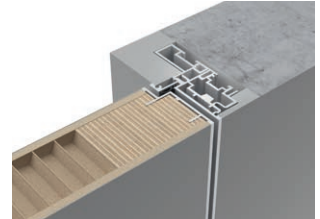

INVISIBLE frame



PLANAR frame

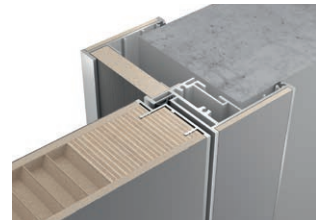

PLANAR frame with insert

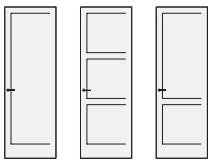

101 126 103

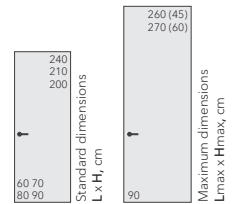

CORDA-60

CLASSIC STYLE DOORS



UNIDOOR frame

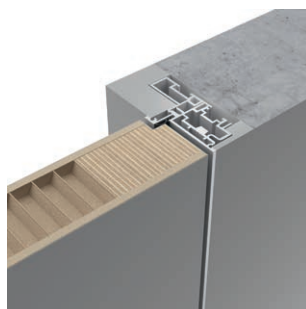

INVISIBLE frame

CORDA-60, 127P, L01 Bianco / UNIDOOR

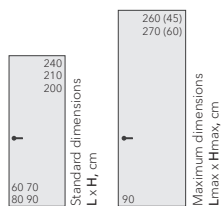
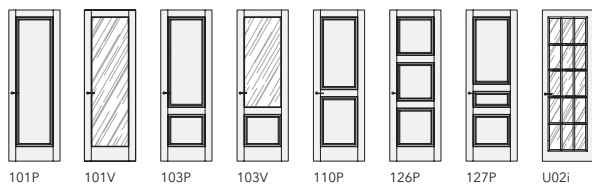

GRAND-60

CLASSIC STYLE DOORS



UNIDOOR frame

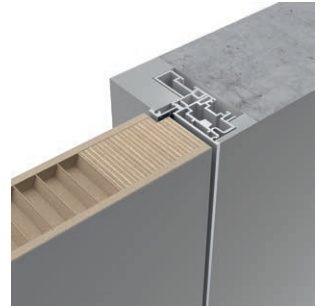

INVISIBLE frame

GRAND-60, GR01, L01 Bianco / UNIDOOR

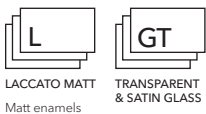
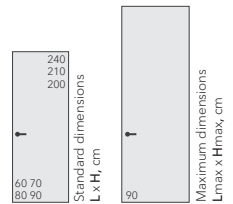
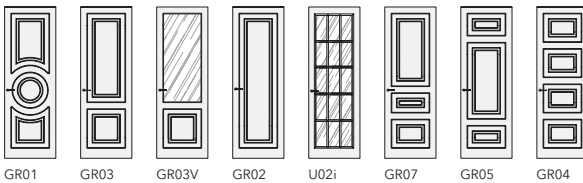

PRIMA-60

CLASSIC STYLE DOORS



UNIDOOR frame



INVISIBLE frame

PRIMA-60, P, L01 Bianco / UNIDOOR

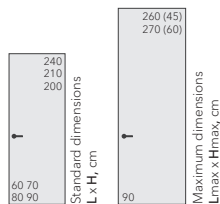
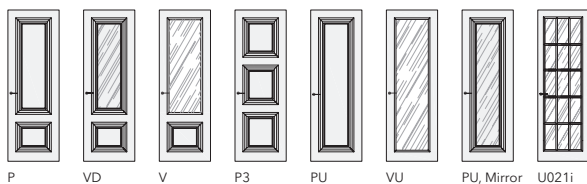

STELLA

CLASSIC STYLE DOORS



UNIDOOR frame

STELLA, PD, L01 Bianco / UNIDOOR

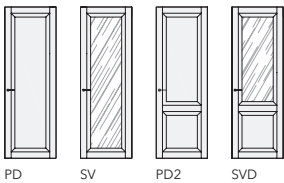

PD

SV

PD2

SVD

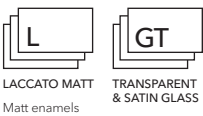
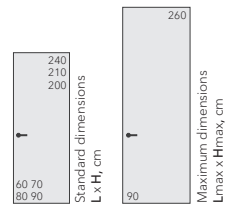

L
LACCATO MATT
Matt enamels

GT
TRANSPARENT
& SATIN GLASS

SLIDER

SLIDING POCKET DOORS AND PARTITIONS



1. SLIDER-FILO, L00 Fondo

2. MINI, L00 Fondo

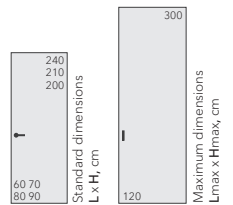

LACCATO MATT
Matt enamels



HPL
Composite material



VENEER NATURAL
Natural wood veneer



LACCATO GLOSS
Gloss enamels



UNIFLEX - 3D
3D milling and relief pattern



GLASS
Painted glass



GLASS MATT
Frosted painted glass



MIRROR



TRANSPARENT & SATIN GLASS



ALUMINIUM
Anodised and polymer coatings

MAGIC

INVISIBLE SLIDING DOOR SYSTEM



MAGIC-FILO, Alu, Vento V17 Rovere Chiaro

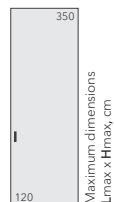

LACCATO MATT
Matt enamels



HPL
Composite material



VENEER NATURAL
Natural wood veneer



LACCATO GLOSS
Gloss enamels



UNIFLEX - 3D
3D milling and relief pattern



GLASS
Painted glass



GLASS MATT
Frosted painted glass



MIRROR



TRANSPARENT & SATIN GLASS



ALUMINIUM
Anodised and polymer coatings

STRATUS

SLIDING DOORS AND PARTITIONS



STRATUS-LAGO, Piatto, G13 Rocca



ceiling track









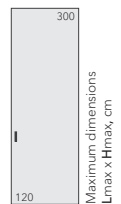



built-in track



wall track



- | | | | | | | | | | |
|--|---|---|---|---|---|---|---|---|---|
|  |  |  |  |  |  |  |  |  |  |
| LACCATO MATT | HPL | VENEER NATURAL | LACCATO GLOSS | UNIFLEX - 3D | GLASS | GLASS MATT | MIRROR | TRANSPARENT & SATIN GLASS | ALUMINIUM |
| Matt enamels | Composite material | Natural wood veneer | Gloss enamels | 3D milling and relief pattern | Painted glass | Frosted painted glass | | | Anodised and polymer coatings |



STRATUS

SLIDING DOORS AND PARTITIONS

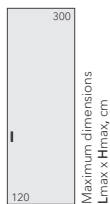

TRANSPARENT
& SATIN GLASS



ALUMINIUM
Anodised and
polymer coatings



STRATUS-SLIM, Piatto, GT02 Trasparente Grafite

STRATUS

SLIDING DOORS AND PARTITIONS



STRATUS-SLIM, Piatto, GT05 Trasparente Sole



GT
TRANSPARENT
& SATIN GLASS

AL
ALUMINIUM
Anodised and
polymer coatings



Maximum dimensions
Lmax x Hmax, cm



TRANSPARENT
& SATIN GLASS



ALUMINIUM
Anodised and
polymer coatings



STRATUS

SLIDING DOORS AND PARTITIONS



STRATUS-SLIM, Pulsar, GT02 Trasparente Grafite

STRATUS

SLIDING DOORS AND PARTITIONS



STRATUS-SLIM, Ritmo, GT02 Trasparente Grafite

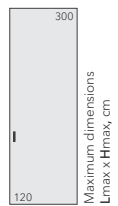

GT
TRANSPARENT
& SATIN GLASS

AL
ALUMINIUM
Anodised and
polymer coatings



GT
TRANSPARENT
& SATIN GLASS

AL
ALUMINIUM
Anodised and
polymer coatings



STRATUS

SLIDING DOORS AND PARTITIONS



1. STRATUS-SLIM, Quadro, GT02 Trasparente Grafite
2. PORTOFINO, Zenit 26
3. MOON, AL03 Soft Gold
4. FORTE Base, DC02 Frassino Grigio, AL03 Soft Gold
5. COVER, V20 Noce Americano

STRATUS

SLIDING DOORS AND PARTITIONS



STRATUS-SLIM, Radar, GT02 Trasparente Grafite

STRATUS

SLIDING DOORS AND PARTITIONS



GT
TRANSPARENT
& SATIN GLASS

AL
ALUMINIUM
Anodised and
polymer coatings

TRANSFORMER

FOLDING SLIDING PARTITION WALLS



TRANSFORMER, Vario, Velino, V16 Noce Canaletto



LACCATO MATT
Matt enamels



HPL
Composite material



VENEER NATURAL
Natural wood veneer



LACCATO GLOSS
Gloss enamels

WALLSTREET

PERMANENT PARTITIONS

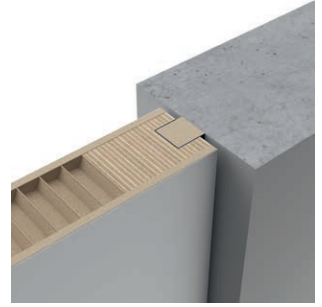

wall connection

WALLSTREET, FILO-60, Alu, Velino V28 Noce Nazionale

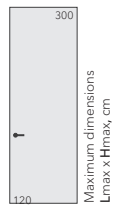

LACCATO MATT
Matt enamels



HPL
Composite material



VENEER NATURAL
Natural wood veneer



LACCATO GLOSS
Gloss enamels



UNIFLEX - 3D
3D milling and relief pattern



ALUMINIUM
Anodised and polymer coatings

COVER

WALL PANELS



COVER, LG14 Ombra Gloss



LACCATO MATT
Matt enamels



HPL
Composite material



VENEER NATURAL
Natural wood veneer



LACCATO GLOSS
Gloss enamels



UNIFLEX - 3D
3D milling and relief pattern





3



1. COVER, Step, US01 Noce Canaletto
2. UNIFLEX-3D, Alu, Step, US01 Noce Canaletto
3. STRATUS, Alu, Step, US01 Noce Canaletto

COVER

WALL PANELS



COVER, Piatto, HP05 Marmo Grigio

DELTApro

METAL ENTRANCE DOORS



DELTApro with decorative panel
HP05 Marmo Grigio



DECORIT
Decorative
material



ALUMINIUM
Anodised and
polymer coatings

ALTO

WALK-IN CLOSETS



ALTO, DC03 Noce Tradizionale / AL08 Black



DECORIT
Decorative
material



ALUMINIUM
Anodised and
polymer coatings



1. ALTO, DC03 Noce Tradizionale / AL08 Black
2. STRATUS - SLIM, Sinqe, GT02 Trasparente Grafite



DC
DECORIT
Decorative
material



G
GLASS
Painted glass



GM
GLASS MATT
Frosted painted
glass



M
MIRROR



GT
TRANSPARENT
& SATIN GLASS



AL
ALUMINIUM
Anodised and
polymer coatings

FORMINA

WARDROBES AND STORAGE SYSTEM



FORMINA, DC03 Noce Tradizionale / AL08 Black

FORTE

BOOKCASES



1. FORTE, DC03 Noce Tradizionale / AL08 Black
2. MOON, AL08 Black



DECORIT
Decorative
material



ALUMINIUM
Anodised and
polymer coatings



DECORIT
Decorative
material



ALUMINIUM
Anodised and
polymer coatings

FORTE Base

BOOKCASES



FORTE Base, DC04 Rovere Termò / AL08 Black

MILAN

DINING TABLES



MILAN, Vox, V15 Rovere Tobacco / AL07 Dark Brown



HPL
Composite
material



VENEER NATURAL
Natural wood
veneer



TRANSPARENT
& SATIN GLASS



ALUMINIUM
Anodised and
polymer coatings



MILAN, GT01 Trasparente / Chrome

LOTUS

COFFEE TABLES



LOTUS, GT02 Trasparente Grafite / Chrome



HPL
Composite
material



VENEER NATURAL
Natural wood
veneer



TRANSPARENT
& SATIN GLASS



ALUMINIUM
Anodised and
polymer coatings

MOON

COFFEE TABLES



MOON, V16 Noce Canaletto / AL08 Black



HPL
Composite
material



VENEER NATURAL
Natural wood
veneer



ALUMINIUM
Anodised and
polymer coatings

PORTOFINO

MODULAR SOFAS



PORTOFINO, PR.D3, Piano 5

* The color palette of fabrics on pg. 110



PORTOFINO, D.PR6L, Piano 4

SKIRTING BOARDS



Concealed plinth **MINI**, insert L01 Bianco

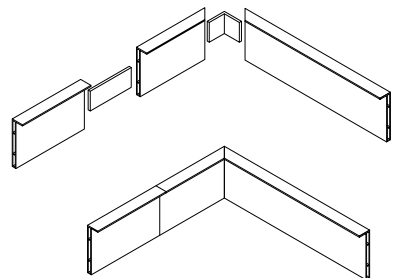

Connectors
for plinth **MINI**

MINI with insert

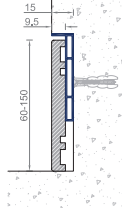

NP9

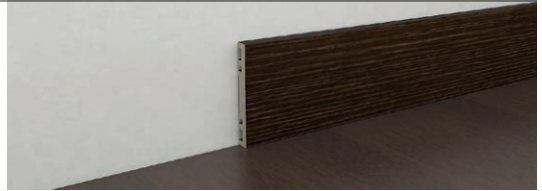
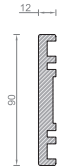

NA10

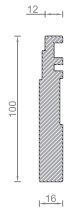

GIOTTO

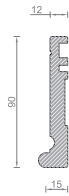

PRIMA

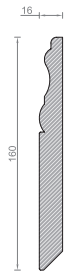

LACCATO MATT
Matt enamels



VENEER NATURAL
Natural wood veneer



UNION CONTRACT

PRODUCTION AND SUPPLY OF DOORS AND
FURNITURE TO VARIOUS BIG PROJECTS

UNION CONTRACT is a division that deals with the contract supply of various doors, wall panels and furniture for hospitality, offices, medical and other institutions. Thanks to many years of experience and possessing a large-scale production with modern Italian equipment, the company is able to carry out any projects in set terms under efficient proposal and at reasonable prices.

WE OFFER manufacture and supply of:

- Interior doors and partitions of any design up to 3.5 m high
- Entrance and technical doors
- Fire rated doors
- Basic and non-standard cabinet furniture
- Interior decoration with wall panels
- Upholstered furniture



WALL PANELS



DOORS



OFFICE PARTITIONS



WALK-IN CLOSET



HOTEL LOBBY



CONTRACT DOORS



MEETING ROOM



BIG LINE, "made in EU"
Finishes - Aluminium (pg. 109)



ROBOQUATTRO S, COLOMBO "made in ITALY"
Chrome Matt, Black, Chrome, White, Gold



MELODY, "made in EU"
Finishes - Aluminium (pg. 109)



GIRA, COLOMBO "made in ITALY"
Chrome Matt

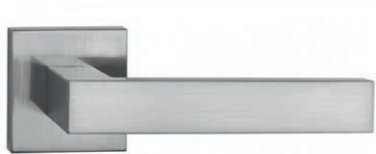

SQUARE, "made in EU"
Finishes - Aluminium (pg. 109)



PUNTO minimal, "made in ITALY"
Finishes - Aluminium (pg. 109)



CINTO, "made in EU"
Finishes - Aluminium (pg. 109)



NAXOS, FORME "made in ITALY"
Chrome Matt, Black, Chrome, White



BIG LINE with insert, "made in EU"
Finishes - Aluminium (pg. 109)

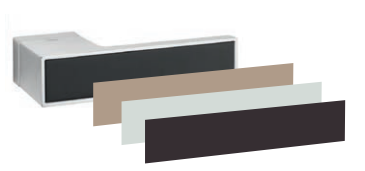

BIG LINE handle insert finishes
are shown pp. 98-108



Handle only



Handle with key PAT

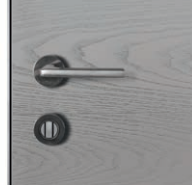

Handle with WC lock



Handle with YALE lock

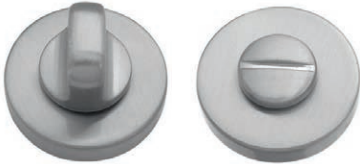

Latch CD 49, COLOMBO "made in ITALY",
Chrome matt



Latch PT 19 BZG, COLOMBO, "made in ITALY",
Chrome Matt, Black, Chrome, White, Gold



Latch PUNTO WC, "made in ITALY"
Finishes - Aluminium (pg. 109)



Latch 3045 RE, "made in EU"
Finishes - Aluminium (pg. 109)



POLARIS, AGB "made in ITALY"
Magnetic silent lock
Chrome mat, Gold, Black, White



HOOK, AGB "made in ITALY"
Lock for sliding door
Chrome mat, Gold, Black, White

COLOMBO finishes

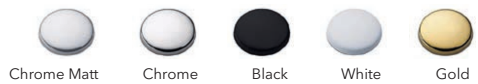

FORME finishes



AGB finishes

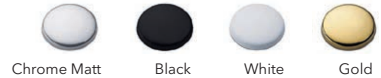

LACCATO MATT



Painted with matt enamels in production environment on specialized equipment "made in ITALY".

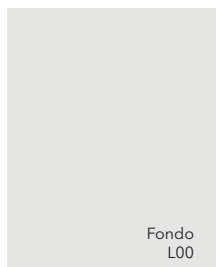

The finishing Fondo is a primer for subsequent painting in any colour with any effects

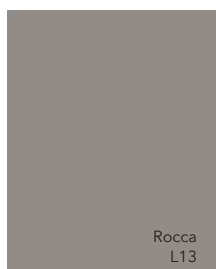
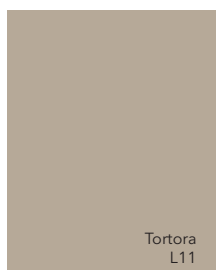
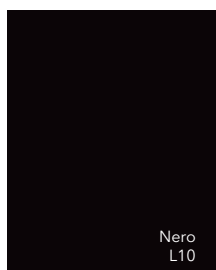
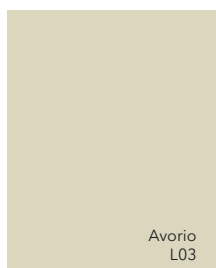
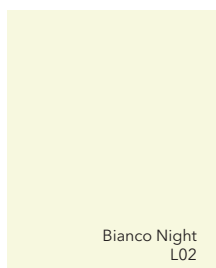

LACCATO GLOSS



High quality 90 Gloss finish, achieved by applying 8 layers of lacquer and intermediate sanding on specialized equipment "made in ITALY".

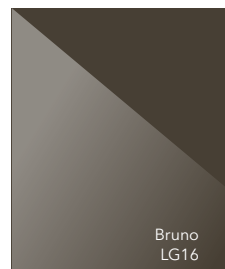
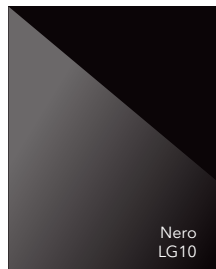
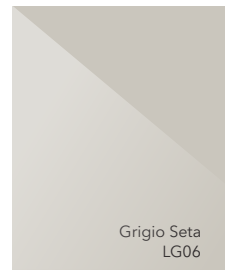
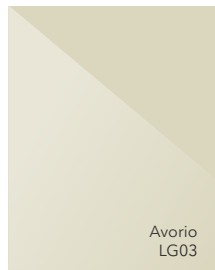
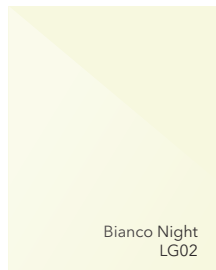
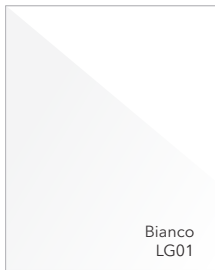

DECORIT 
Abrasion-resistant decorative material

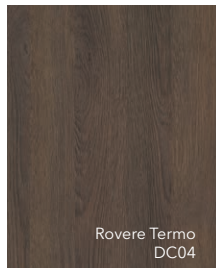
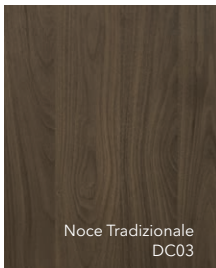

HPL 
Composite decorative material

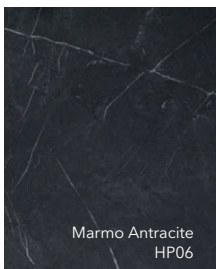
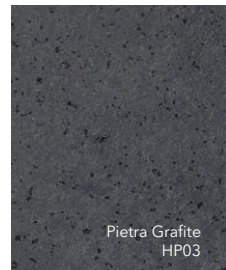
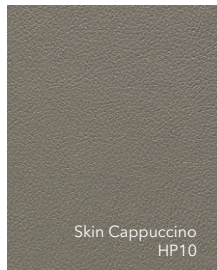
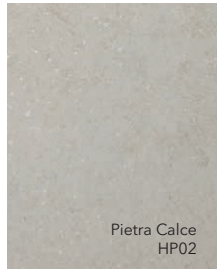
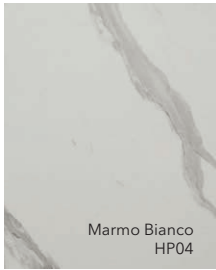

GLASS 

Glossy glass. Painting on specialized equipment in production conditions.

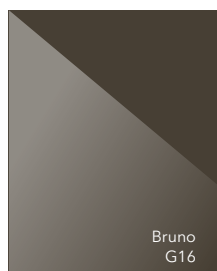
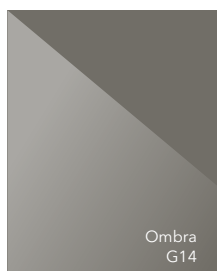
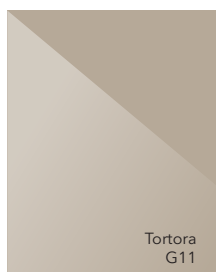
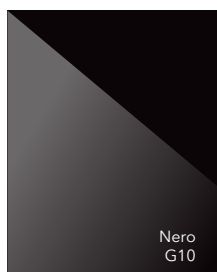
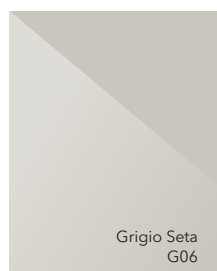
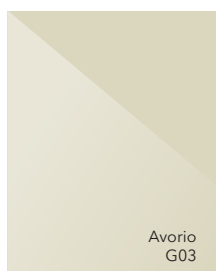
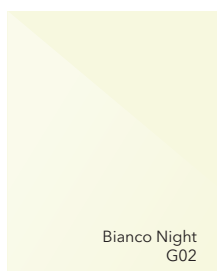
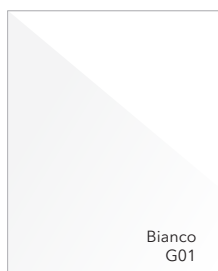

GLASS MATT 

Frosted glass. Painting on specialized equipment in production conditions.

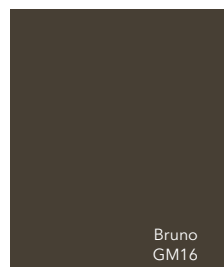
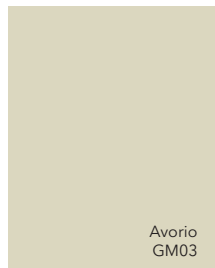
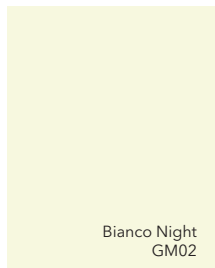

MIRROR 
Colored mirrors

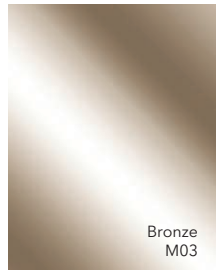

TRANSPARENT & SATIN GLASS

Translucent safety glass with decorative effects

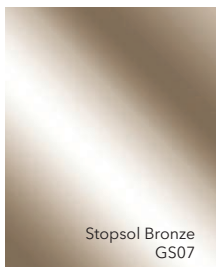
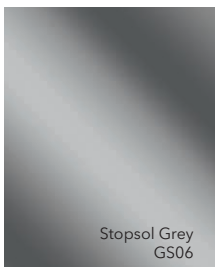
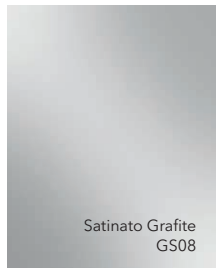
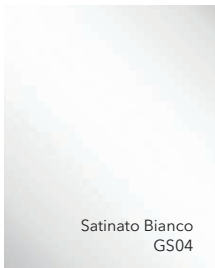

VENEER NATURAL 

Natural wood veneer with open pores matt lacquer finish

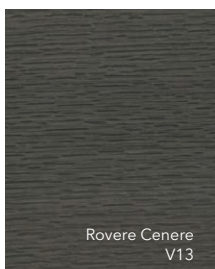
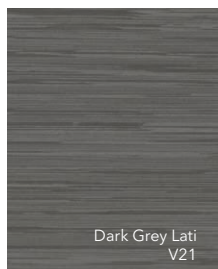
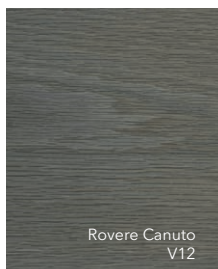
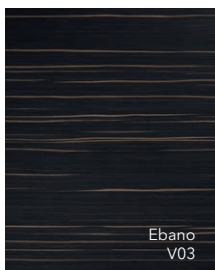
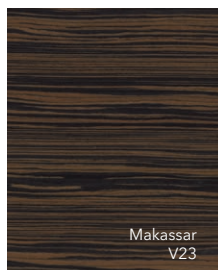
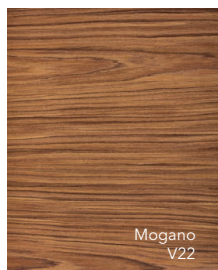
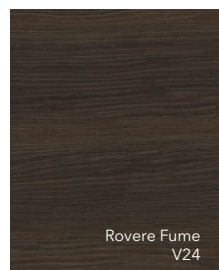
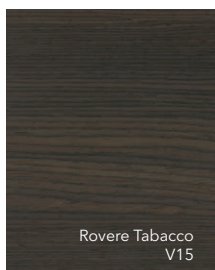
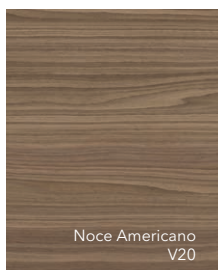
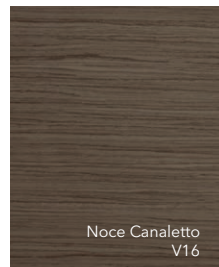
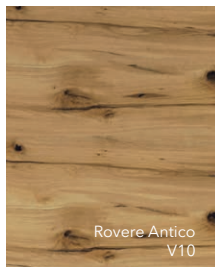

UNIFLEX-3D



3D milling on solid lamella and relief pattern on natural veneer

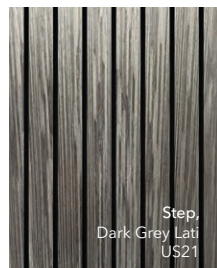
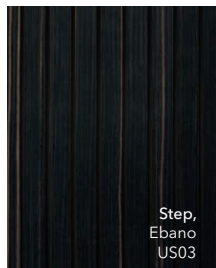
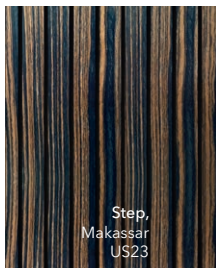
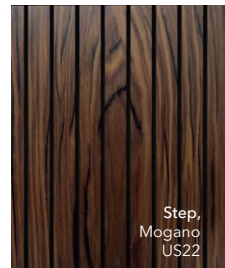
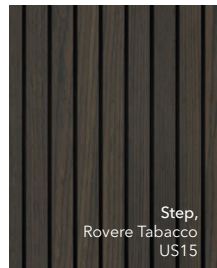
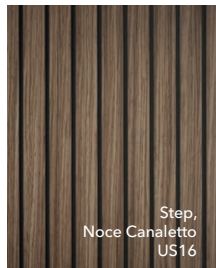
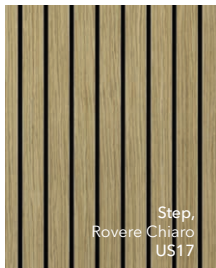
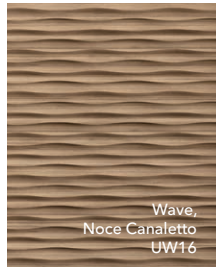

LAMINAM
Ceramic panel

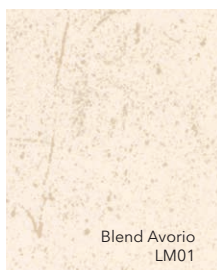

Blend Avorio
LM01



Fokos Sale
LM13



Fokos Terra
LM14



Pietra Grigio
LM24



Pietra Grey
LM23



Fokos Piombo
LM11

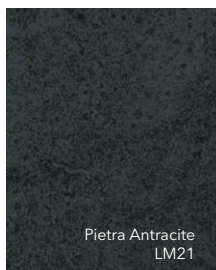

Pietra Antracite
LM21

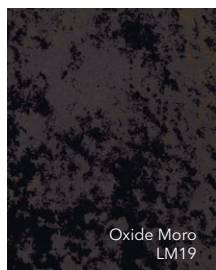

Oxide Moro
LM19

ALUMINIUM



AL09 - high quality anodised electrochemical coating.

AL02 - AL08. Polymer powder (made in Italy) coating in electrostatic field

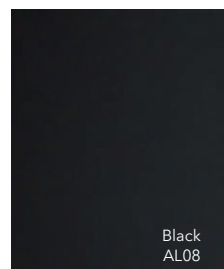
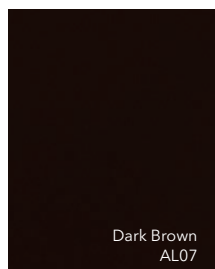
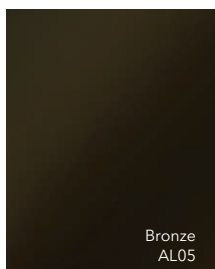
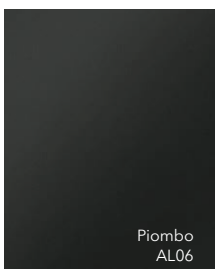
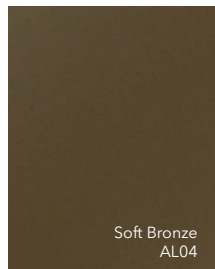
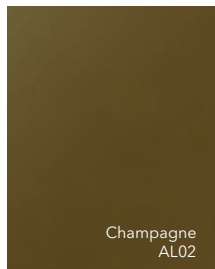
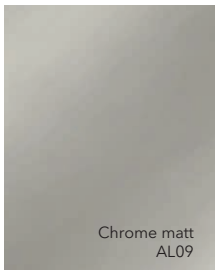

PORTOFINO TEXTILE

Durable, abrasion-resistant fabrics

PIANO



VERONA



ZENIT

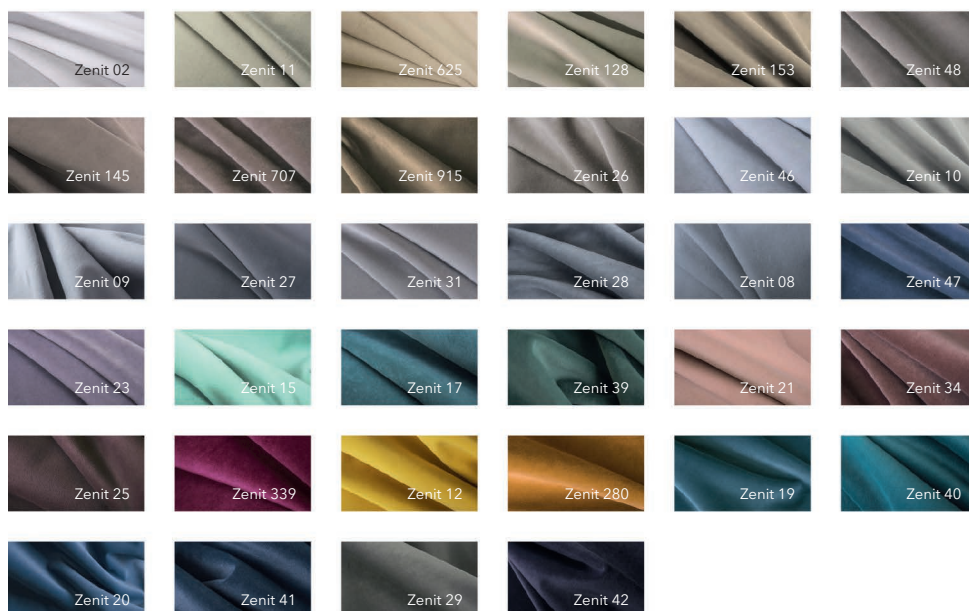

Via Flavio Baracchini, 2 - 20100 Milano (Italia)
+39 388 9532054 | +7 915 1557851
info@unionporte.it
www.unionporte.it



UNION reserves the right to make changes that do not impair quality to the products presented in this catalog at any time without prior notice. The company is not responsible for incomplete similarity between the originals and the samples in the catalog. Colors and finishes shown in the sample catalog may differ from the original. For more detailed information or to get acquainted with real samples of color solutions / finishes, we recommend contacting the showrooms of the company.

Instagram  uniondoors

Pinterest  uniondoors

Archiproducts  union

+39 388 9532054
info@unionporte.it
www.unionporte.it